

# INTOVA

*Inspired by Innovations*

## ***Sport HD*** ***Xtreme Imaging***

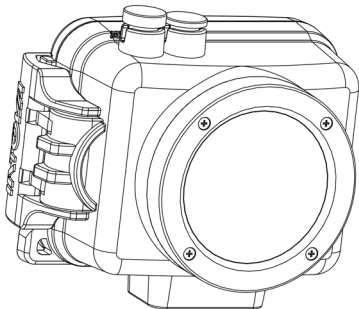

### Table of Contents :

Preface.....	1
Main features.....	1
Computer operating system requirements.....	1
Prestart Guide.....	2
Basic installation.....	3
Video mode.....	5
Photo mode.....	10
Playback mode.....	15
Settings.....	16

## Preface :

Thank you for purchasing an Intova Sport HD. SP1 utilizes the 1080p High Definition Video format and is waterproof to 60 meters/200 feet. Visit [www.intova.net](http://www.intova.net) to view the wide range of mount options available to help you fully utilize this great camera. Enjoy!!

## Main features :

### \* Video resolution :

1080P	( 1920×1080	30fps )
720P	( 1280×720	30fps )
WVGA1	( 848×480	60fps )
WVGA	( 848×480	30fps )
VGA	( 640×480	30fps )

### \* Photo resolution :

12M	4000X3000Pixels (by interpolation)
8M	3200X2400Pixels (by interpolation)
5M	2592X1944Pixels
3M	2048X1536Pixels

### \* 1.5 inch TFT LCD

### \* 4x Digital Zoom (no zoom in 1080P mode)

### \* 140° wide angle lens

### \* Built in rechargeable 1400mAh lithium-ion battery

### \* Supports micro SD card up to 32GB (4GB SDHC CLASS 4 or above is recommended)

## Accessories :

Manual CD / USB cable / TV out cable / hand strap

## Computer operating system requirements :

### Windows 2000/XP:

- 128 MB RAM, minimum 125 MB free disk space.
- Available USB Interface.
- Recommended screen resolution 1024 × 768 pixels or higher.
- 16-bit color or higher display adaptor.

**Windows Vista :**

- 800MHz processor and 512 MB of system memory .
- 20GB hard driver with minimum 15GB of available space .
- Support for Super VGA graphics.
- Available USB Interface.

**Windows 7 :**

- 1 GHz or faster 32-bit(x86) or 64-bit (x64) processor.
- 1GB RAM (32-bit) or 2GB RAM (64-bit).
- 16GB available system RAM(32-bit) 或 20GB(64-bit) .
- WDDM1.0 or higher version driver's Direct X9 graphics device.

**Macintosh :**

- Power Macintosh G3 500 MHz or higher .
- Mac OS X version 10.2.6 or later .
- 128 MB minimum available system RAM (256 MB recommended), 150 MB free disk space .
- 800 x 600 or higher-resolution monitor displaying millions of colors .

*Note: This hardware is plug and play compatible when used on a Mac. The included software is for Windows operating systems only.*

**Handling notice before use:**

- Do not attempt to disassemble the camera as there are high voltage parts and dangerous electric shock can occur.
- Do not leave the camera in direct sunlight or near heat sources.
- If camera becomes hot during use, turn off the power immediately.
- For storage, remove the memory card and keep camera in a cool, dry place with housing door slightly open
- SPI floats. Intova flotation strap (optional accessory) is recommended as extra precaution for water use.

## Description:

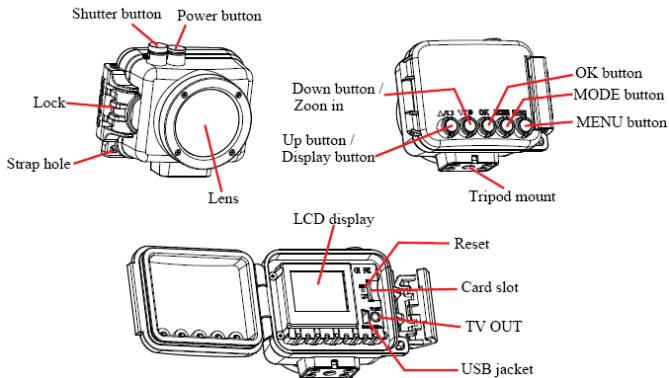

## Basic installation :

### Open the housing :

Follow the directions in the figure below to open the housing.

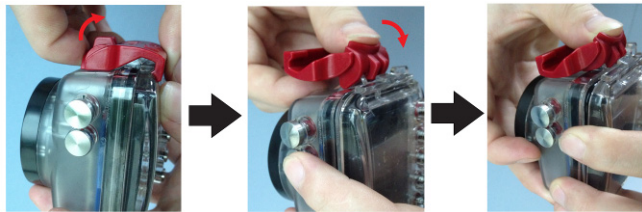

### Insert memory card :

Follow the indicated direction in the figure below to insert Micro SD memory card. After the card is inserted, the icon  will show on LCD screen.

*\* Turn off power when inserting or removing memory card.*

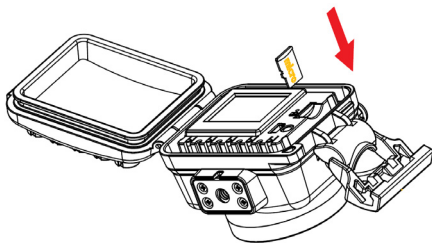

**Notes :**

1. Format the memory card before use
2. If the DV does not work with the memory card, please try a new card.
3. The DV can't record a video or take a photo without a properly inserted memory card.

**USB charging and transferring :**

Connect your computer to DV with USB cable. After connection, press the power button, and then use Up/Down buttons to select MDSC/CHARGE/OPEN.

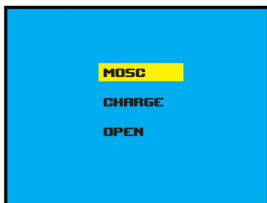

**MDSC :** Enter to download video or image files.

**CHARGE :** Charge or recharge battery. Full charging time is around 6 hours.

**OPEN:** Recharge the battery and operate the DV.

**TV OUT :**

Connect DV and TV with TV cable to display DV files on TV.

## Basic operation :

### FUNCTIONS:



Video



Photo



Playback

### POWER :

Press "POWER button" to turn on / turn off °

### MODE SWITCH :

Press "MODE button" to switch between VIDEO/PHOTO/PLAYBACK.

### VIDEO/CAMERA :

Press "Shutter button" to take a video or photo

### PLAYBACK :

Press "MODE button" to enter Playback mode to view video and image files.

### DISPLAY :

When in video or camera mode, press Up button to turn off LCD and save battery power.

### RESET :

If DV shuts down and the buttons don't respond, use a tooth pick or other sharp point to press Reset button and restart DV.

## Video mode :

Default setting of DV is video mode. Press "Shutter button" to start or stop recording.

### Digital zoom :

Use "Down button" to zoom in on scene while selecting targets. The zoom factor will be displayed on the LCD, and can be increased to a maximum of 4X (resolution drops as an image is magnified)

*\* Can't zoom in 1080P mode.*

### Video mode display :

The following icons show the various settings displayed on the LCD in Video mode.

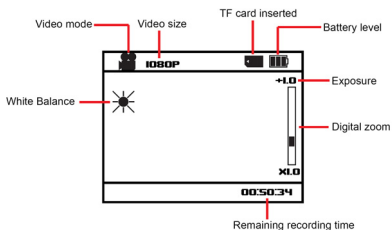

## Settings :

In Video mode, press “MENU Button”, and use UP / DOWN buttons to select desired adjustment setting. The following icons represent all of the functional settings in Video mode. AUDIO / SIZE / EV / WHITE B / METERING / CONTRAST / SHARPNESS / EFFECT / RECYCLE / VIDEO FLIP.



\* **Audio :** In the setting list, use the UP / DOWN buttons to select “AUDIO”, and press “OK button” to enter setting. Choose ON or OFF, and press “OK button” to confirm selection, then press MENU button to return.

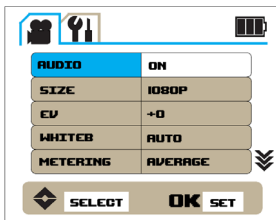
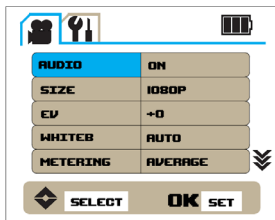

\* **Size** : In the setting list, use the UP / DOWN buttons to select “SIZE”, and press “OK button” to enter setting. There are 1080P / 720P / WVGA1 / WVGA / VGA. After selection, press “OK button” to confirm, then press MENU button to return.

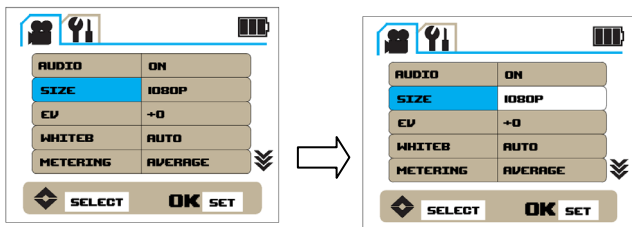

\* **EV** : In the setting list, use the UP / DOWN buttons to select “EV”, and press “OK button” to enter setting. There are +2 / +1.7 / +1.3 / +1 / +0.7 / +0.3 / 0 / -0.3 / -0.7 / -1 / -1.3 / -1.7 / -2. After selection, press “OK button” to confirm, then press MENU button to return.

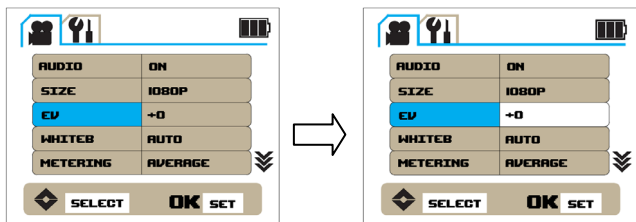

\* **White Balance**: In the setting list, use UP / DOWN buttons to select “WHITE B”, and press “OK button” to enter setting. There are AUTO / SUNNY / CLOUDY / TUNGSTEN / FLUORESCENT / MANUAL. After selection, press “OK button” to confirm, then press MENU button to return.

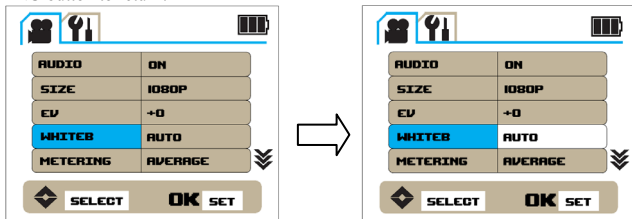

When selecting MANUAL white balance mode and exiting menu, monitor will show blinking manual white balance icon. Aim camera at white balance board and press shutter button to set. To reset manual white balance again, turn camera on and off to get blinking icon.



\* **Metering** : In the setting list, use the UP / DOWN buttons to select “METERING”, and press “OK button” to enter setting. There are AVERAGE / SPOT / CENTER. After selection, press “OK button” to confirm, then press MENU button to return.

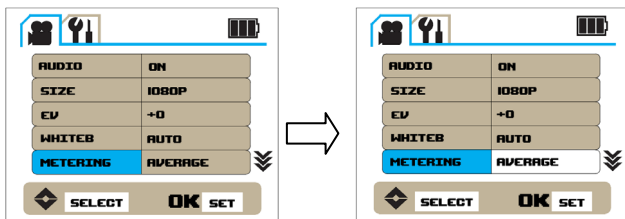

\* **Contrast** : In the setting list, use the UP / DOWN buttons to select “CONTRAST”, and press “OK button” to enter setting. There are STANDARD / HARD / SOFT. After selection, press “OK button” to confirm, then press MENU button to return.

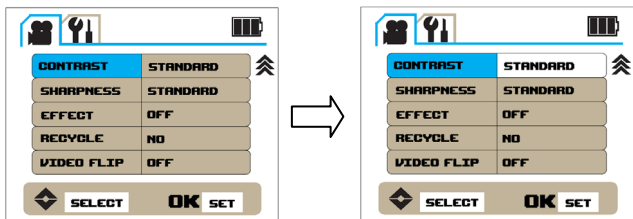

\* **Sharpness** : In the setting list, use the UP / DOWN buttons to select “SHARPNESS”, and press “OK button” to enter setting. There are STANDARD / HARD / SOFT. After selection, press “OK button” to confirm, then press MENU button to return.

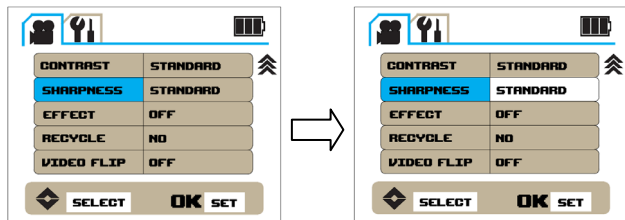

\* **Effect** : In the setting list, use the UP/ DOWN buttons to select “EFFECT”, and press “OK button” to enter setting. There are OFF/ ART / SEPIA / NEGATIVE / MONOCHROME / VIVID. After selection, press “OK button” to confirm, then press MENU button to return.

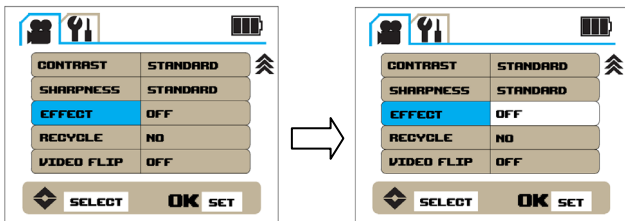

\* **Recycle** : In the setting list, use the UP/ DOWN buttons to select “RECYCLE”, and press “OK button” to enter setting. There are NO/1 MIN/ 2 MINS/ 3 MINS/ 4 MINS/ 5 MINS/ 10 MINS/ 15 MINS. After selection, press “OK button” to confirm, then press MENU button to return.

*Notice* : This function directs the DV to save files in the SD card automatically at the specified time interval. Once the SD card is full, the earliest file will be deleted and covered with a new file.. Select the capacity of your SD card carefully, and save the files on a computer to avoid data loss.

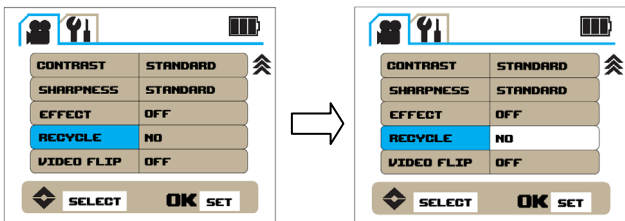

\* **Video Flip** : In the setting list, use the UP/ DOWN buttons to select “VIDEO FLIP”, and press “OK button” to enter setting. Choose ON or OFF, and press “OK button” to confirm the selection, then press MENU button to return.

*Notice*: This function allows image to be flipped 180 degrees if camera is used upside down.

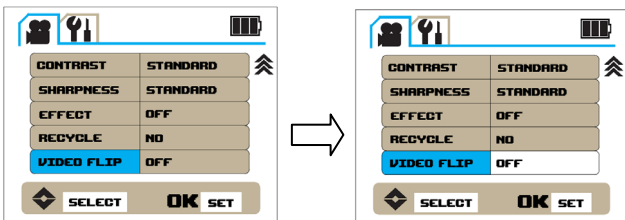

## Photo mode :

Press the **MODE button** to enter Photo mode. Adjust the DVR to take photos of the objects (viewed from the LCD), press the Shutter button to take photos.

## Digital zoom :

Use the “**Down button**” to zoom in on scene while selecting targets. The zoom factor will be displayed on the LCD, and can be increased to a maximum of 4X (resolution drops as an image is magnified).

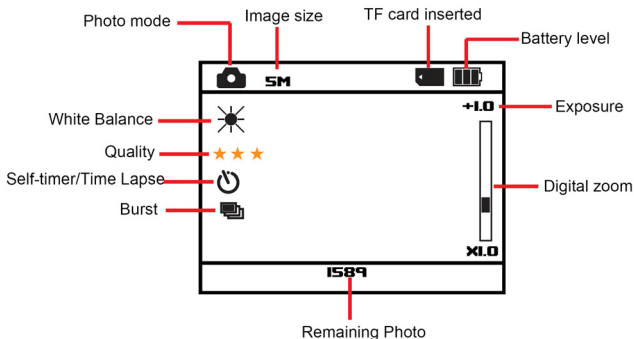

## Settings :

In the Photo mode, press the “**MENU Button**”, and use the UP / DOWN buttons to select desired adjustment setting. The following icons represent all of the functional settings in Photo mode. They include SIZE / EV / QUALITY / WHITE B / METERING / CONTRAST / SHARPNESS / EFFECT / SELFTIMER / BURST / PHOTO FLIP / TIME LAPSE.

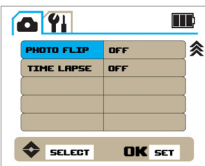

\* **Size** : In the setting list, use the UP / DOWN buttons to select “SIZE”, and press “OK button” to enter setting. There are 12M / 8M / 5M / 3M. After selection, press “OK button” to confirm, then press MENU button to return.

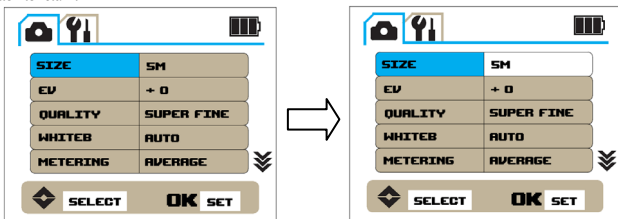

\* **EV** : In the setting list, use the UP / DOWN buttons to select “EV”, and press “OK button” to enter setting. There are +2 / +1.7 / +1.3 / +1 / +0.7 / +0.3 / 0 / -0.3 / -0.7 / -1 / -1.3 / -1.7 / -2. After selection, press “OK button” to confirm, then press MENU button to return.

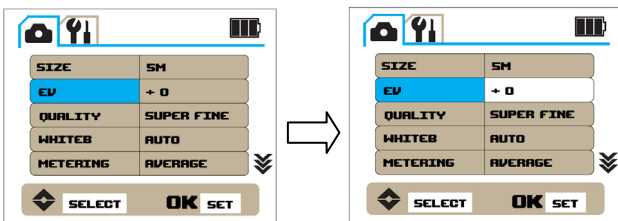

\* **Quality** : In the setting list, use the UP / DOWN buttons to select “QUALITY”, and press “OK button” to enter setting. There are SUPER FINE / NORMAL / FINE. After selection, press “OK button” to confirm, then press MENU button to return.

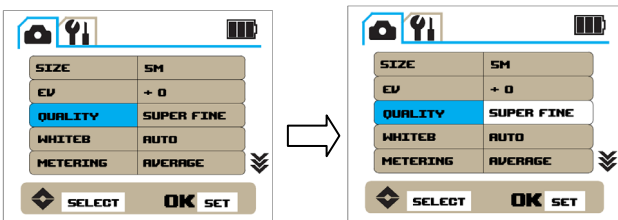

\* **White Balance:** In the setting list, use UP / DOWN buttons to select “WHITE B”, and press “OK button” to enter setting. There are AUTO / SUNNY / CLOUDY / TUNGSTEN / FLUORESCENT / MANUAL. After selection, press “OK button” to confirm, then press MENU button to return.

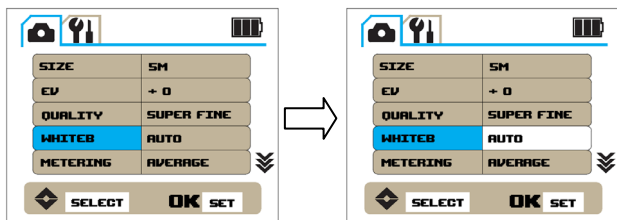

When selecting MANUAL white balance mode and exiting menu, monitor will show blinking manual white balance icon. Aim camera at white balance board and press shutter button to set. To reset manual white balance again, turn camera on and off to get blinking icon.

\* **Metering :** In the setting list, use the UP / DOWN buttons to select “METERING”, and press “OK button” to enter setting. There are AVERAGE / SPOT / CENTER. After selection, press “OK button” to confirm, then press MENU button to return.

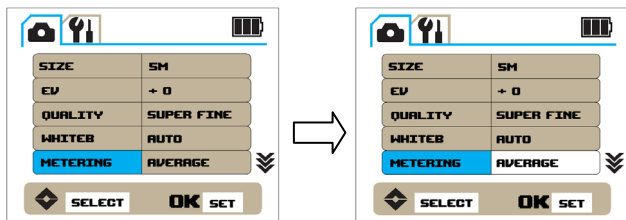

\* **Contrast :** In the setting list, use the UP / DOWN buttons to select “CONTRAST”, and press “OK button” to enter setting. There are STANDARD / HARD / SOFT. After selection, press “OK button” to confirm, then press MENU button to return.

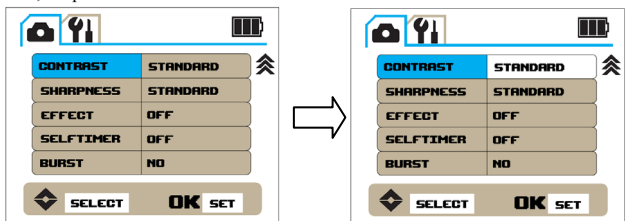

\* **Sharpness** : In the setting list, use the UP / DOWN buttons to select “SHARPNESS”, and press “OK button” to enter setting. There are STANDARD / HARD / SOFT. After selection, press “OK button” to confirm, then press MENU button to return.

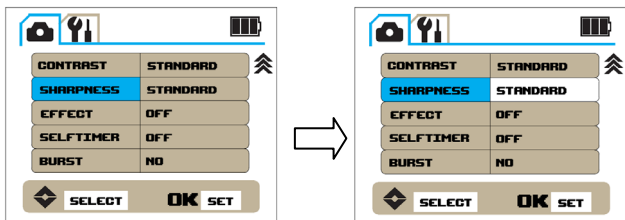

\* **Effect** : In the setting list, use the UP / DOWN buttons to select “EFFECT”, and press “OK button” to enter setting. There are OFF/ ART / SEPIA / NEGATIVE / MONOCHROME / VIVID. After selection, press “OK button” to confirm, then press MENU button to return.

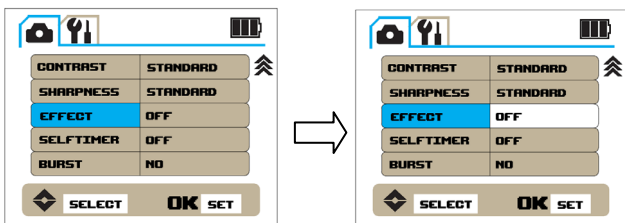

\* **Self timer** : In the setting list, use the UP / DOWN buttons to select “SELF TIMER”, and press “OK button” to enter setting. There are OFF/ 5 SECONDS / 10 SECONDS / 30 SECONDS / 60 SECONDS. After selection, press “OK button” to confirm, then press MENU button to return.

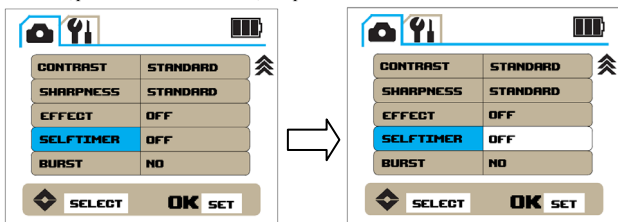

\* **Burst** : In the setting list, use the UP / DOWN buttons to select “BURST”, and press “OK button” to enter setting. There are NO/ 3 PICS / 5 PICS / 10 PICS. After selection, press “OK button” to confirm, then press MENU button to return.

**Notice:** *This function will allow the camera to rapidly shoot the selected number of images in a “burst”.*

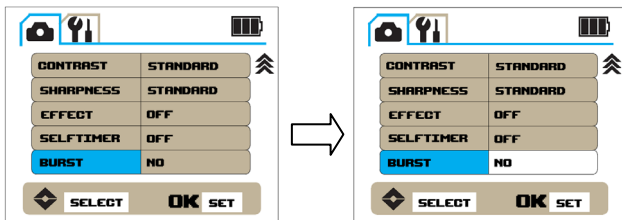

\* **Photo flip** : In the setting list, use the UP / DOWN buttons to select “PHOTO FLIP”, and press “OK button” to enter setting. Choose ON or OFF, and press “OK button” to confirm the selection, then press MENU button to return.

**Notice:** *This function allows image to be flipped 180 degrees if camera is used upside down.*

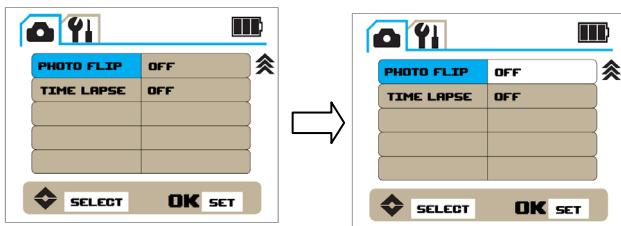

\* **Time lapse** : In the setting list, use the UP / DOWN buttons to select “TIME LAPSE”, and press “OK button” to enter setting. There are OFF / 1 SECOND / 2 SECONDS / 5 SECONDS / 10 SECONDS / 30 SECONDS / 60 SECONDS / 120 SECONDS / 180 SECONDS. After selection, press “OK button” to confirm, then press MENU button to return.

**Notice** : *After selection, press the Shutter button to work this function. Photos will be taken automatically at each specific time lapse. Press the Shutter button again to stop.*

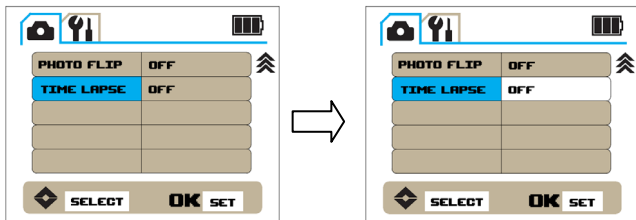

## Playback mode :

Press Mode button to enter into Playback mode. The LCD will display as follows. Press UP/DOWN buttons to search for the videos or photos you would like to view, then press OK button to play/view.

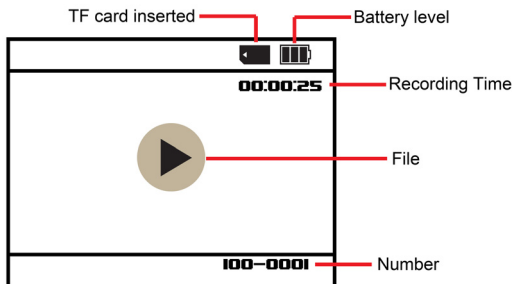

### Video playback :

Use UP/DOWN buttons to select the video to be viewed, and press **OK button** to play. Press **OK button** again to stop the video, or press UP button to fast forward.

### Photo playback :

Use UP/DOWN buttons to select photo to be viewed.

### Playback Settings:

After entering Playback mode, press **MENU button** to enter function settings. Use **Up/Down buttons** to select Delete or Slide Show.



\* **Delete** : Use UP/DOWN buttons to select the video or photo to be deleted. Press MENU button, choose “DELETE” and press OK button to enter setting list. Use UP/DOWN buttons to select **YES (Single image)** or **DELETE ALL**.

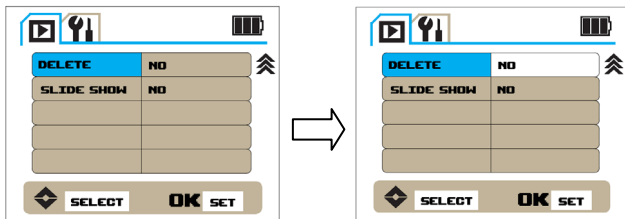

\* **Slide Show** : In Playback mode, press Menu button to enter setting list then use UP/DOWN buttons to select “SLIDE SHOW”. There are NO / 1 SECOND / 3 SECONDS / 5 SECONDS. After selection, press OK button to confirm. Press Menu button to return and start slide show display. Press Menu button once again to stop.

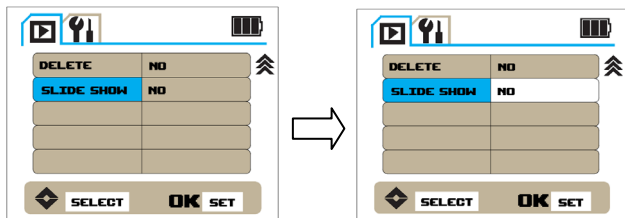

## Settings:

Press Menu button, then press UP button and OK button to enter settings in any mode. There are LANGUAGE · VOLUME · DATE · CLOCK · FORMAT · SYS.RESET · AUTO OFF · LIGHT FREQ · TV OUT · STAMP · LCD OFF · VERSION.



\* **Language** : Use UP/DOWN buttons to select "LANGUAGE", and press OK button to enter setting list. There are ENGLISH、PORTUGUESE、русский、KOREAN、SPANISH、ITALIANO、DEUTSCH、FRANÇAIS、日本、繁體中文、简体中文. After selection, press OK button to confirm, and press Menu button to return.

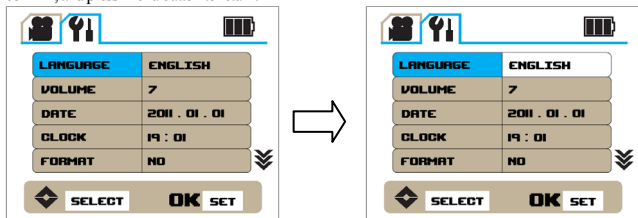

\* **Volume** : Use UP/DOWN buttons to select "VOLUME", and press OK button to enter setting list. There are seven volume levels. Full volume is number 7. After selection, press OK button to confirm, and press Menu button to return.

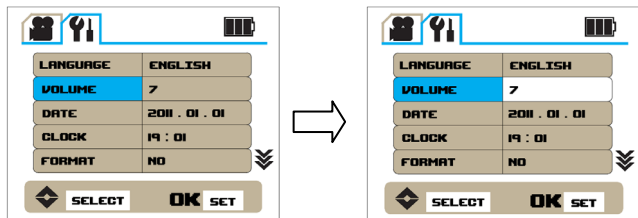

\* **Date** : Use UP/DOWN buttons to select "DATE", Press OK button to enter setting list. Use UP/DOWN buttons to adjust Year/Month/Day, and press OK button to confirm. After selection, press OK button again to confirm all, and then press Menu button to return.

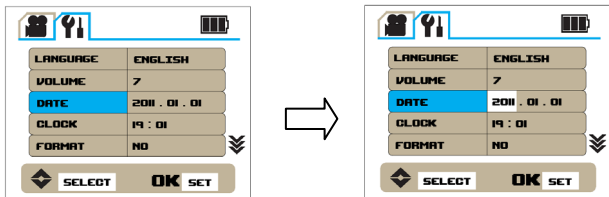

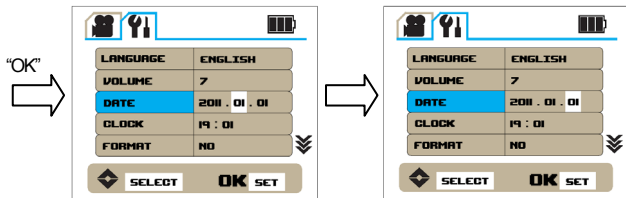

\* **Clock** : Use UP/DOWN buttons to select “CLOCK”, and press OK button to enter setting list. Use UP/DOWN buttons again to adjust hour / minute, and press OK button to confirm the setting. After adjustment, press OK button again to confirm, then press Menu button to return.

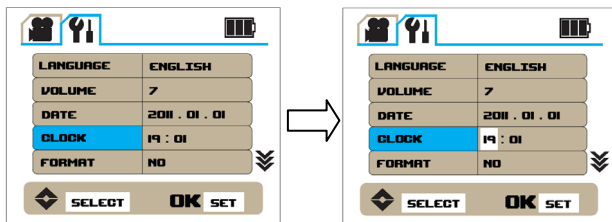

\* **Format** : Use UP/DOWN buttons to select “FORMAT”, and press OK button to enter setting list. Choose YES or NO, and press OK button to confirm the selection. Press Menu button to return.

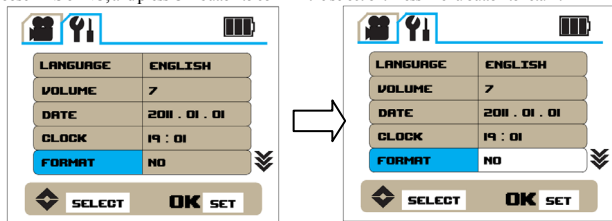

\* **Sys. reset** : Use UP/DOWN buttons to select "SYS.RESET", press OK button to enter setting list. Choose YES or NO, and press OK button to confirm the selection. Press Menu button to return.

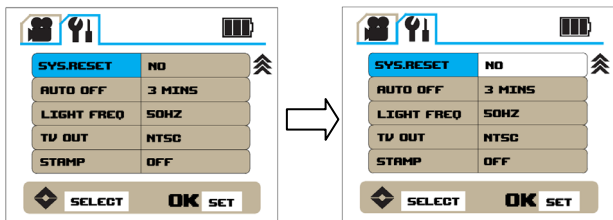

\* **Auto off** : Use UP/DOWN buttons to select "AUTO OFF", and press OK button to enter setting list. There are OFF / 1 MIN / 3 MINS / 5 MINS. After selection, press OK button to confirm, then press Menu button to return.

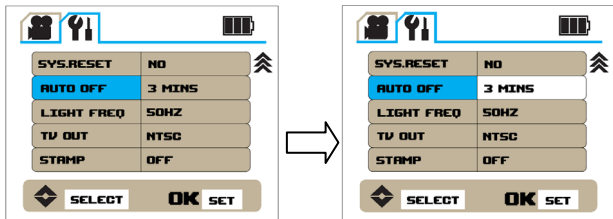

\* **Light freq** : Use UP/DOWN buttons to select "LIGHT FREQ", and press OK button to enter setting list. There are 50 HZ / 60 HZ. Adjust according to the frequency standard of country. After selection, press OK button to confirm, then press Menu button to return.

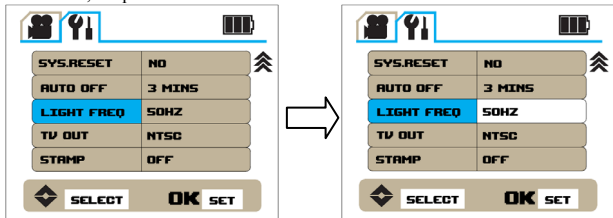

\* **TV OUT** : Use UP/DOWN buttons to select "TV OUT", and press OK buttons to enter setting list. Options are NTSC / PAL. Adjust according to country standard. After selection, press OK button to confirm, then press Menu button to return.

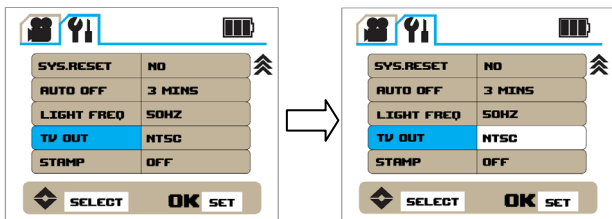

\* **Stamp** : Use UP/DOWN buttons to select "STAMP", and press OK button to enter setting list. There are OFF · DATE · DATE / CLOCK. If selected, the time detail will be shown on video and photos. After selection, press OK button to confirm, then press Menu button to return.

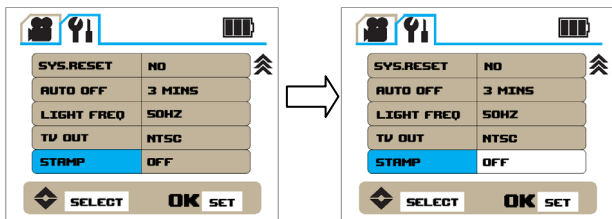

\* **LCD off** : Use UP/DOWN buttons to select "LCD OFF", press OK button to enter setting list. There are OFF · 1 MIN · 3 MINS. After selection, press OK button to confirm, then press Menu button to return.

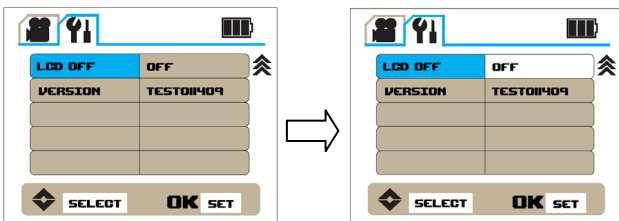

\* **Version** : Use UP/DOWN buttons to select "VERSION" to view the current software version.

